

Quick Guide for DS902 Door phone Intercom



Overview

This document describes the features of Door phone Intercom (DS902) and uses several examples to illustrate its settings.

Pre-Requisites

- SN902 V2 Base
- SN902 V2 Handset (HS) with new firmware which supports the DS902
- DS902 intercom

Feature List

- Works with SN902 v2 SPK handset, base and land line.
- Supports either two way intercom (Intercom to handset) or land line call via the base unit.
- Outgoing call from DS: calls up to 3 numbers
- Incoming call to DS: programmable auto-answer mode
- Accepts 2 to 4-digits code to control the door relay
- Stores 90 numbers on authorized guest list: if caller ID matches the pre-stored number in the phone book, the DS will open the door/gate automatically without inputting the password.

Option 1: Setting DS by DS Main Menu

- 3 sets of phone numbers for outgoing calls: Via MENU, 1, 5, PSTN
- 90 sets of authorized guests for incoming call: Via MENU,2 → PhoneBook
- Menu for DS: Menu → 1. KeyGuard → DoorPhone

Item	Description	Default Value
Ring Timeout	Outgoing call from DS. Setting the ring timeout after pushing the "Call" button.	35 seconds. (Range: 15~ 254)
Unlock Code	Setting 2 to 4-digit code of opening door. 1 digit access not supported.	****
Auto-Answer	This function will be enabled always for setting DS from HS directly.	ON

Relay Timer	Setting the relay duration.	2 seconds. (Range: 1~15)
Call Mode	Selecting destination (telephone/HS) to answer the call from DS.	PSTN/HSID: 13 (HSID Range: 11~19, 21~29, 31~39, 41~49)

Table 1: The Descriptions of DS items

- **Menu for DS – You can see the menu from DS (menu → 1)**

Menu → 1. DoorPhone



Figure 1: The Menu of DS

1. Ring Time Out

You can enter the value of ring timeout (15~254 seconds) here, and if you enter an invalid value and it will revert to the previous valid value stored.



Figure 2: Setting Ring Timeout

2. Unlock Code

You can enter a 2 to 4-digits code (it can be composited by 0~9 and *) here, and the length of code must be 2 to 4 digits.



Figure 3: Setting Code of Opening Door

3. Auto-Answer

It is enabled always for the feature that can set DS by cordless HS.

4. Relay Timer

You can enter the value of relay duration to control the relay of DS, and if you enter an invalid value and it will revert to the previous valid value stored.



Figure 4: Setting Relay Duration

5. Call Mode

You can select a HS or telephone here for answering the call from DS.

- **PSTN**: Just save and **DO NOT FORGET** to set telephone number or nothing will happen when pushing the “Call” button. You can follow the steps as Figure 5 to set the number and you can enter 3 sets of number to DS.

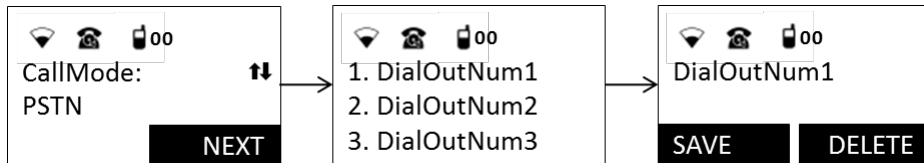

Figure 5: Setting Call Mode (PSTN).

- **INTERCOM**: Press up/down key, you will see INTERCOM and can set HS ID after pressing ‘NEXT’, if you enter an invalid ID and it will revert to the ID stored before. Please note that if you choose PSTN and save, the HS ID will be reset to default ID.

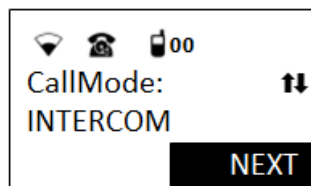

Figure 6: Setting Call Mode (HS).



Figure 7: Setting HS ID.

- **After DS Setting**

You must power cycle the DS off/on, in order for any change to take effect

Option 2: Setting DS by cordless HS

- You **have to know the ID of DS before setting** this way.
- These functions can be set using **HS11 and HS12**.
- There is a programming menu for setting DS.
- You can explore the KEY MAP of HS (see Figure 8) first before setting.

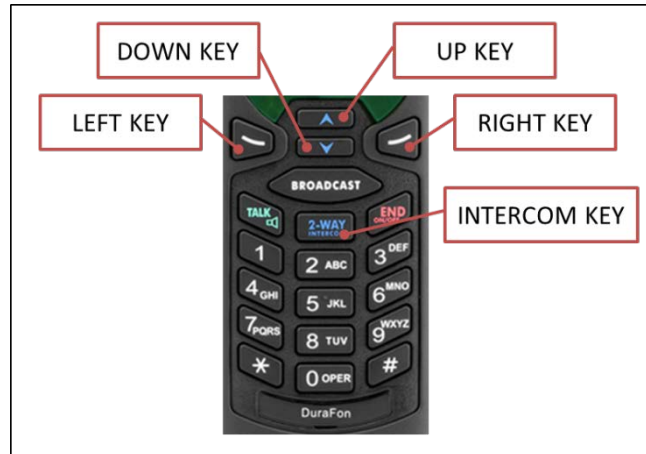

Figure 8

- You should understand the setting flow of the HS and can reference Figure 9. If you want to leave the programming menu, press the **END** key anywhere and it will return to IDLE state of HS.

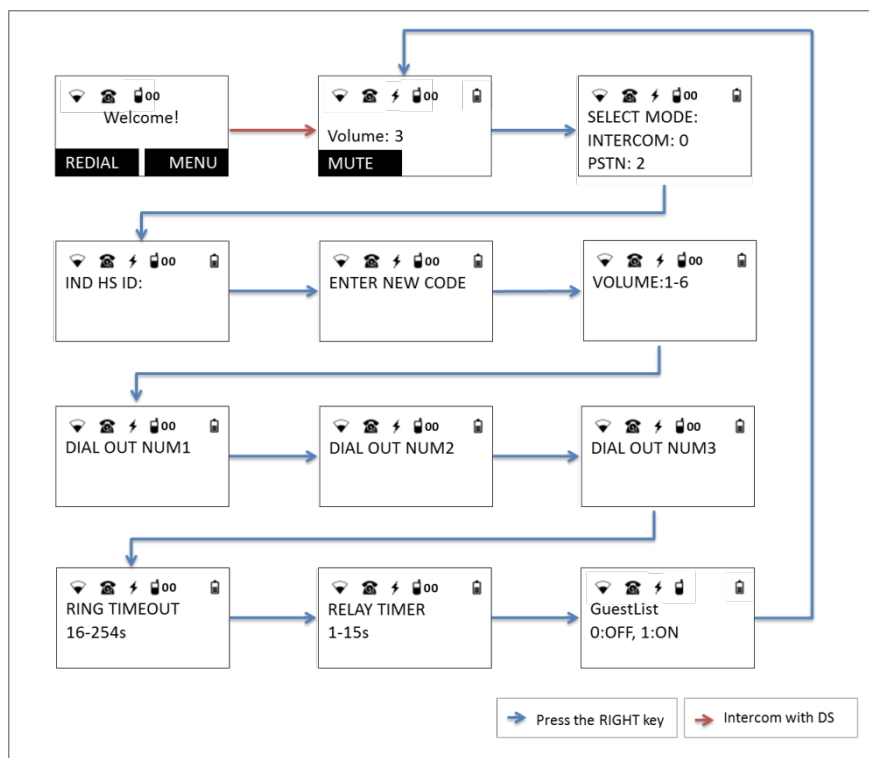

Figure 9: The flow of programming menu.

Item	Description
Call Mode	There are two modes for DS, one is INT mode and the other is PSTN mode. You can refer the section ' Call Mode ' to fully understand it.
Indication HS ID	In INT mode, a HS ID will be assigned to DS and the HS will ring when DS 'Call' button is pressed. You can see the section ' Call Mode ' to fully understand it .
Code	Enter the code to open the door. See section ' Unlock Code '.
Speaker Volume	The volume of DS and the default value is 3.
Dial Out Nmber1	In PSTN mode, the telephone will ring when pushing 'Call' button of DS and you should store the 'Dial Out Number' in advance. See section ' Call Mode '.
Dial Out Nmber2	It is the same as the item 'Dial Out Number1'.
Dial Out Nmber3	It is the same as the item 'Dial Out Number1'.
Ring Timeout	See ' Ring Time Out '.
Relay Timer	See ' Relay Timer '.
Guest List	Enable/disable the guest list. When you enable it, the guest, whose number is in your guest list, will cause the door /gate to open automatically when he/she makes a call to the DS.

Table 2: The Descriptions of Programing Menu Items.

- Push the call button to register

Try the easy way to register your DS, just follow the steps listed below:

1. Using the admin HS (The ID is 11 or 12) to assign an ID for DS
 - A. Menu → 9.System
 - B. Enter Base ID for entering the System menu, in our case, the ID is 10.
 - C. After entering the menu, go to the item '4.Assign HS'.
 - D. Assign an ID you want for DS.
2. Long press the **REGISTER KEY of BASE** until in register mode.
3. Long press the **CALL BUTTON of DS** and **power it on** and it will be registered to the base automatically.

- HS To DS – You can set DS by HS directly

We provide another convenient way to modify DS mode, code, speaker volume...etc. **You have to know the ID of your DS before setting.** For example, a user wants to modify the DS mode to INT mode and he/she will make an intercom call to DS, and press the **RIGHT** key, the HS will show the user the option of mode (INTERCOM:0, PSTN:2) and press key '0'. After setting, the DS mode will be changed to mode INT automatically.

The following section will show you the setting steps of 'HS to DS'.

● Call Mode

Steps:

1. Press the 'INTERCOM' key and enter the ID of DS.
2. Press the 'RIGHT' key until you see the options of changing DS mode (see Figure 10)
3. Press '0' or '2' to change the mode you want.

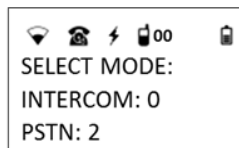

Figure 10

● Indication HS ID

Steps:

1. Press the 'INTERCOM' key and enter the ID of DS.
2. Press the RIGHT key until the HS show you the string 'IND HS ID' such as Figure 11.
3. Enter the indication HS ID you want, and note that **you can't enter the DS' ID.**

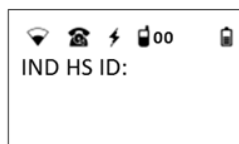

Figure 11

- **Code**

Steps:

1. Press Key 'INTERCOM' and enter the ID of DS.
2. Press the RIGHT key until the HS shows you the string 'ENTER NEW CODE' such as Figure 12.
3. Enter the new code of opening door.

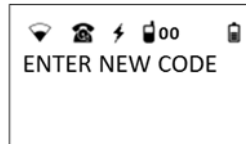

Figure 12

Note:

The code can be a 2 to 4-digits, and if you want to use a 2 or 3-digits to be your code, you should enter '#' to tell the DS the completion of changing code. For instance: You want to use '11' be your code, you should type '11#'.

- **Speaker Volume**

Steps:

1. Press Key 'INTERCOM' and enter the ID of DS.
2. Press the RIGHT key until the HS show you the string 'VOLUME: 1-6' such as Figure 13.
3. Press the value to change the volume you want.

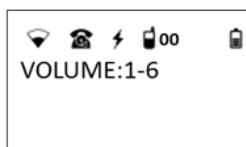

Figure 13

● **Dial Out Numbers 1/2/3:**

Steps:

1. Press Key 'INTERCOM' and enter the ID of DS.
2. Press the RIGHT key until the HS show you the string 'DIAL OUT NUM1'/'DIAL OUT NUM2'/'DIAL OUT NUM3' such as Figure 14/15/16.
3. Enter the number you want.

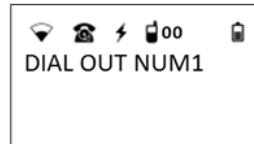

Figure 14

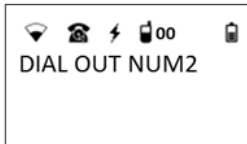

Figure 15

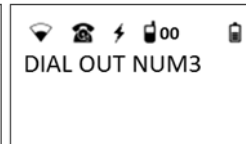

Figure 16

Note:

1. The MAX length of dial out number is 16.
2. The number can be composed by 0 to 9 and '*' just.
3. If your number's length is smaller than 16, you should type '#' to tell DS the procedure is done. For example: your number is '123456789' and you should type '123456789#'.
4. You can type '#' only to clear it.

● **Ring Timeout**

Steps:

1. Press Key 'INTERCOM' and enter the ID of DS.
2. Press the RIGHT key until the HS show you the string 'RING TIMEOUT' such as Figure 18.
3. Enter the value of timeout you want.

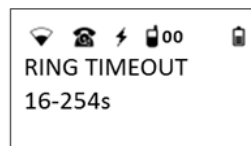

Figure 18

Note:

1. The value of 'RING TIMEOUT' should be 16 to 254.
2. If you want to complete the setting, you can type '#'.
3. It will become default value when you type '#' only.

- **Relay Timer**

Steps:

1. Press Key 'INTERCOM' and enter the ID of DS.
2. Press the RIGHT key until the HS show you the string 'RELAY TIMER' such as Figure 19.
3. Enter the value of relay timer you want.

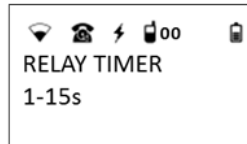

Figure 19

Note:

1. The value of 'RELAY TIMER' should be 1 to 15.
2. If you want to complete the setting, you can type '#'.
3. It will become default value when you type '# only'

- **Guest List**

Steps:

1. Press Key 'INTERCOM' and enter the ID of DS.
2. Press the RIGHT key until the HS show you the string 'RELAY TIMER' such as Figure 20.
3. Enter the value of relay timer you want.



Figure 20

Firmware Upgrade

- You will need a micro USB cable.
- The upgrade tool of EnGenius such as Figure 20.
- OS: Windows 7

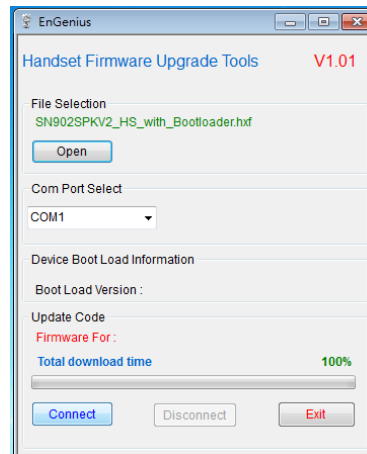

Figure 20

Steps:

1. Connect DS and your PC by micro USB cable first.
2. Launch the upgrade tool, select the *.hxf file we provide and select COM port.
3. Click the button 'Connect'.
4. Turn on DS and the upgrade process will begin.

Test Examples

Case 1: Test PSTN mode.

- Ring Timeout: By Default.
- Code: "1234"
- Relay Duration: By Default.
- Call Mode: PSTN, Telephone number: 104
- Connect telephone line #101 to SN902SPK base

Step 1: Push "Call" button → The telephone (#:104) is ringing.

Step 2: Hang on the phone → 1. Say something to verify voice, 2. Press code "1234" and door will open. (You can hear the voice of relay.)

Step 3: Hang off and call DS (#:101)

Step 4: The incoming call will be answered directly and automatically by DS.

Case 2: Test HS2 HS function.

- Ring Timeout: By Default.
- Code: "1234"
- Relay Duration: By Default.
- Call Mode: **INTERCOM**, HS ID: 13
- The number of DS: 101

Step 1: Push "Call" button → The HS is ringing.

Step 2: Press TALK Key of HS → 1. Say something to verify voice, 2. Press code "1234" and door will open. (You can hear the voice of relay.)

Step 3: Finish the call.

Case 3: Test the function that will open door directly without inputting the code when the CID was stored in advance.

- Ring Timeout: By Default.
- Relay Duration: By Default.
- Call Mode: **PSTN**, Telephone number: 103
- The number of DS: 101

Step 1: Save the number '103' into phone book.

Step 2: Use the telephone of #:103 to call DS.

Step 3: The Door will be opened without code.

Installation Instruction:

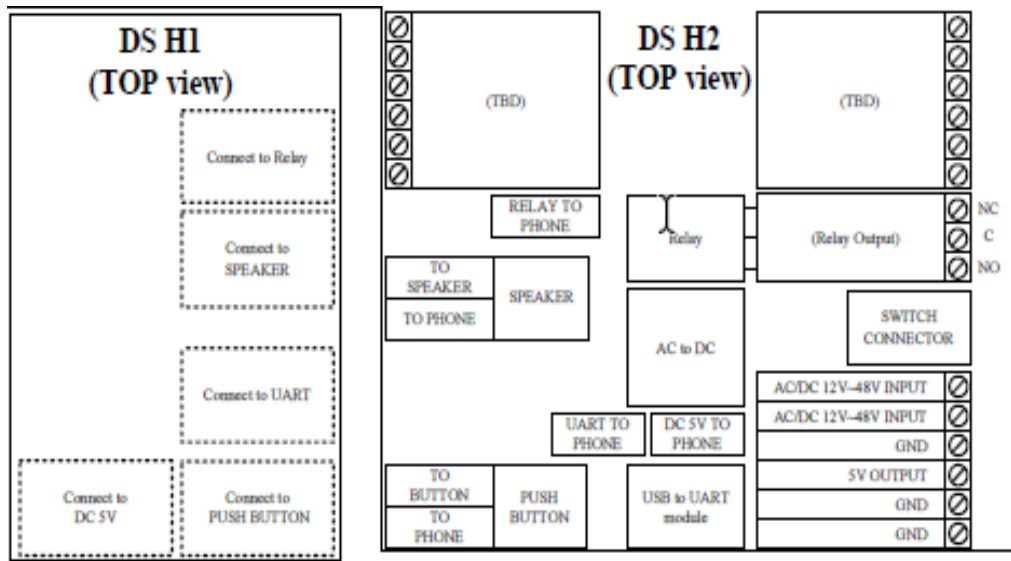

Technical Specifications:

- IP 65 Rating
- Adjustable call timer
- Supplied as a kit SN902 Handset, Base & DS902
- Physical: H 160 mm x W 109 mm x D 41 mm
- Frequency 915 ~ 928MHz
- RF Power Peak 708mW & Average:76Mw
- Channel Spacing 200kHz
- Frequency Hopping Rate 100 per second
- Antenna Gain 2dBi(long) & 0.5dBi (short)
- Operating Temperature 25°C (-10 ~ 60°C)
- Power source 12-48 Volt DC / AC
- Storage temperature (-40 ~ 70°C)
- Humidity (0 % ~ 75 %)
- Weight 0.65kg
- Receiver Sensitivity BER (Input Level : -108 dBm) $\leq 0.01(160/16000)$
- Transmission Data Rate 170.67 KHz
- Half duplex
- Modulation MSK

E&OE